

MANWAY ACCESSORIES

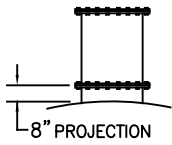

FLANGED MANWAY
EXTENSION WITH
BOLTED COVER
24"-30"-36" DIA.
UP TO 60" TALL

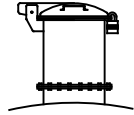

LOCKABLE HINGED
MANWAY COVER
AVAILABLE FOR 30" DIA.
EXTENSIONS ONLY

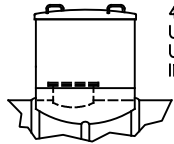

MANWAY ENCLOSURE
48" DIAMETER
UP TO 60" TALL
USING 20" I.D.
INTERNAL MANWAY

NOMINAL SHIPPING
WEIGHT: 14,550 POUNDS

KEY	
LIFT LUG	
ANCHOR STRAP	
DEFLECTION PORT	
DEADMAN	

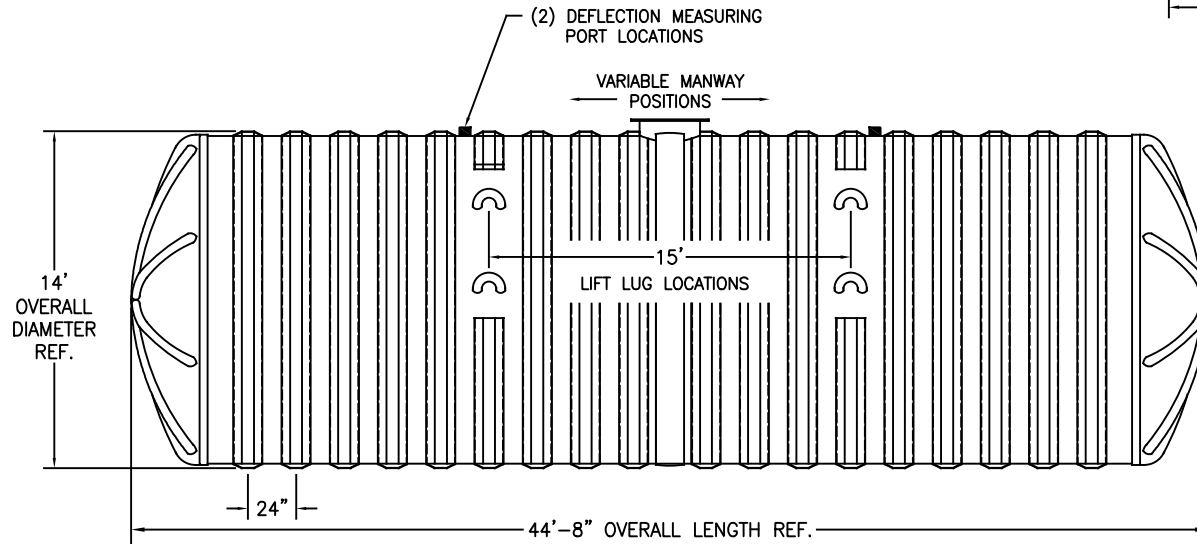
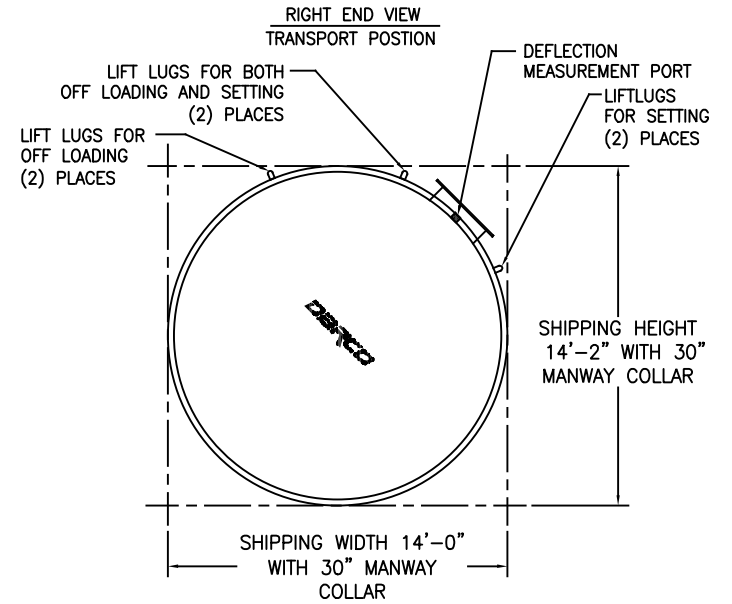

WARNING
MINIMUM SOIL DEPTH ABOVE TANK WHEN USING DEADMAN ANCHORS IS 2 FEET.

NOTE:
THE DECISION TO USE AN ANCHORING SYSTEM IS THE RESPONSIBILITY OF THE OWNER OR HIS REPRESENTATIVE. NOT EVERY TANK WILL REQUIRE ANCHORING.



Rev Date 9/9/2020	14'-0" I.D. 45,000 GAL. FIBERGLASS HORIZONTAL TANK	Sheet 1 of 1
Rev Let INT. REL.		
Darco Incorporated Post Office Box 68 Cottonwood, AZ 86326 800-232-8660 - www.darcoinc.com		