

MANWAY ACCESSORIES

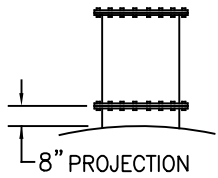

FLANGED MANWAY EXTENSION WITH BOLTED COVER
24"-30"-36" DIA.
UP TO 60" TALL

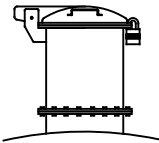

LOCKABLE HINGED MANWAY COVER
AVAILABLE FOR 30" DIA.
EXTENSIONS ONLY

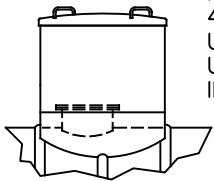

MANWAY ENCLOSURE
48" DIAMETER
UP TO 60" TALL
USING 20" I.D.
INTERNAL MANWAY

NOMINAL SHIPPING WEIGHT: 6,400 POUNDS

KEY	
LIFT LUG	
ANCHOR STRAP	
DEFLECTION PORT	
DEADMAN	

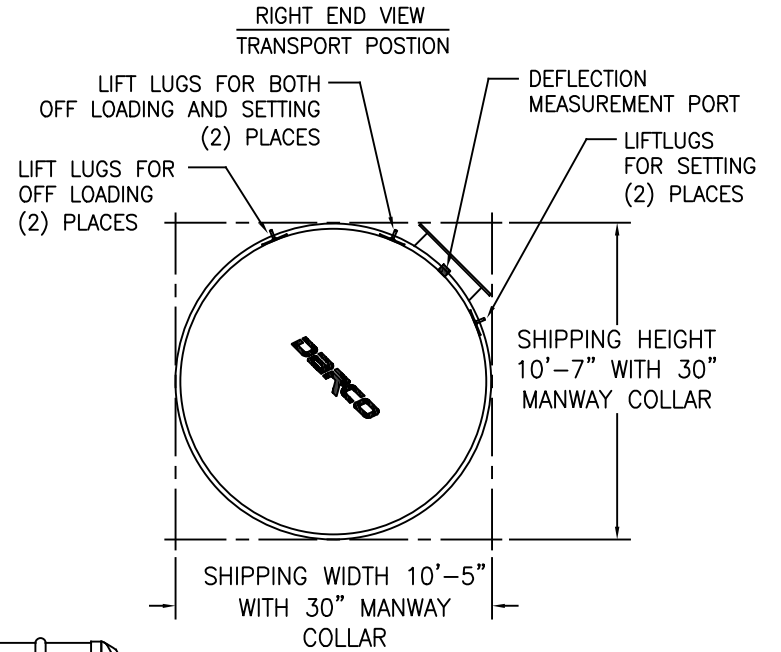
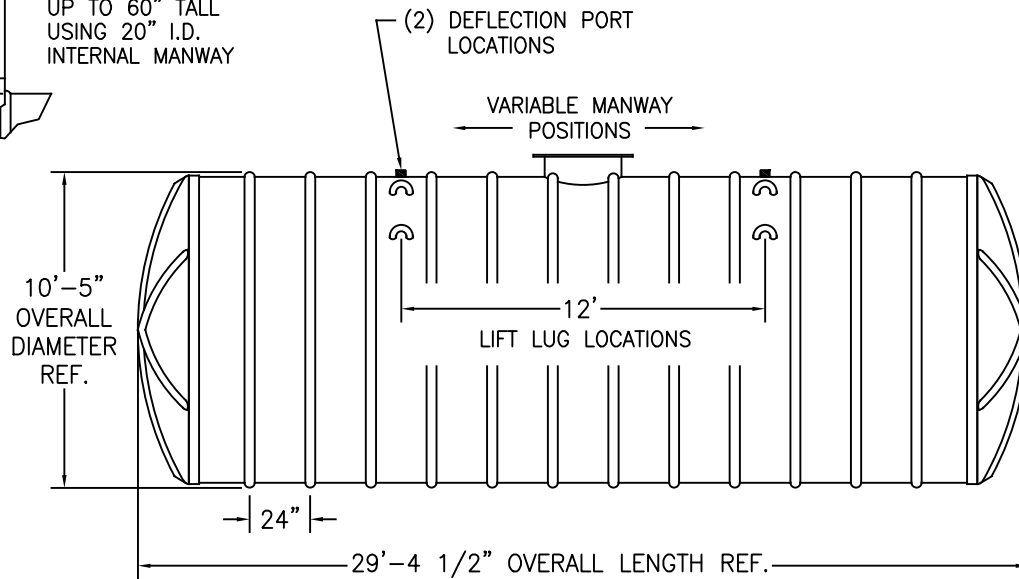

WARNING
MINIMUM SOIL DEPTH ABOVE TANK WHEN USING DEADMAN ANCHORS IS 2 FEET.

NOTE:
THE DECISION TO USE AN ANCHORING SYSTEM IS THE RESPONSIBILITY OF THE OWNER OR HIS REPRESENTATIVE. NOT EVERY TANK WILL REQUIRE ANCHORING.

DARCO FRP UNDERGROUND TANKAGE		
Rev Date 9/4/2020	10'-0" I.D. 15,000 GAL. FIBERGLASS HORIZONTAL TANK	Sheet 1 of 1
Rev Let INT. REL.		
Darco Incorporated Post Office Box 68 Cottonwood, AZ 86326 800-232-8660 - www.darcoinc.com		